

XUK8AKSNL2

Photoelectric sensors XU, photo electric laser sensor, XUK, BGS, Sn 1 m, 12...24 VDC, cable 2 m



Main

Range of product	Telemecanique Photoelectric sensors XU
Series name	General purpose single mode
Electronic sensor type	Photo-electric sensor
Sensor name	XUK
Sensor design	Compact 50 x 50
Detection system	Diffuse with background suppression
Material	Plastic
Type of output signal	Discrete
Supply circuit type	DC
Wiring technique	3-wire
Discrete output type	PNP or NPN
Discrete output function	1 NO or 1 NC programmable
Electrical connection	Cable
Cable length	2 m
Product specific application	-
Emission	Infrared laser, modulated diffuse with background suppression class 1
[Sn] nominal sensing distance	1 m diffuse with background suppression

Complementary

Enclosure material	PC
Lens material	PMMA
Maximum sensing distance	1 m diffuse with background suppression
Minimum object diameter for detection	2 mm
Output type	Solid state
Add on output	Without, <= 50 mA with overload and short-circuit protection
Cable composition	5 x 0.34 mm ²
Wire insulation material	PVC
Cable outer diameter	6 mm
Status LED	1 LED (green) for supply on 1 LED (yellow) for output state 1 LED (red) for alignment assistance
[Us] rated supply voltage	12...24 V DC with reverse polarity protection
Supply voltage limits	10...36 V DC
Switching capacity in mA	<= 100 mA (overload and short-circuit protection)
Switching frequency	<= 250 Hz
Maximum voltage drop	<1.5 V (closed state)
Current consumption	35 mA no-load
Maximum delay first up	300 ms
Maximum delay response	2 ms
Maximum delay recovery	2 ms
Setting-up	Sensitivity adjustment by potentiometer
Depth	50 mm
Height	50 mm
Width	18 mm

The information provided in this documentation contains general descriptions and/or technical characteristics of the performance of the products contained herein. This documentation is not intended as a substitute for and is not to be used for determining suitability or reliability of these products for specific user applications. It is the duty of any such user or integrator to perform the appropriate and complete risk analysis, evaluation and testing of the products with respect to the relevant specific application or use thereof. Neither TWSS Holding nor any of its affiliates or subsidiaries shall be responsible or liable for misuse of the information contained herein.

Net weight	0.19 kg
Kit composition	With XUZA51 bracket fixing

Environment

Product certifications	CE
Ambient air temperature for operation	-25...55 °C
Ambient air temperature for storage	-30...70 °C
Vibration resistance	7 gn (f = 10...55 Hz) conforming to IEC 60068-2-6
Shock resistance	10 gn (duration = 11 ms) conforming to IEC 60068-2-27
IP degree of protection	IP65 double insulation conforming to IEC 60529

Packing Units

Unit Type of Package 1	PCE
Number of Units in Package 1	1
Package 1 Height	4.2 cm
Package 1 Width	9.7 cm
Package 1 Length	13.2 cm
Package 1 Weight	228 g
Unit Type of Package 2	S02
Number of Units in Package 2	12
Package 2 Height	15 cm
Package 2 Width	30 cm
Package 2 Length	40 cm
Package 2 Weight	3.2 kg

Offer Sustainability

Sustainable offer status	Green Premium product
Environmental Disclosure	Product Environmental Profile
Circularity Profile	End of Life Information
California proposition 65	WARNING: This product can expose you to chemicals including: Diisononyl phthalate (DINP), which is known to the State of California to cause cancer, and Di-isodecyl phthalate (DIDP), which is known to the State of California to cause birth defects or other reproductive harm. For more information go to www.P65Warnings.ca.gov
For all Reach Rohs enquiries contact us at	sustainability@tesensors.com

Contractual warranty

Warranty	18 months
----------	-----------

Dimensions

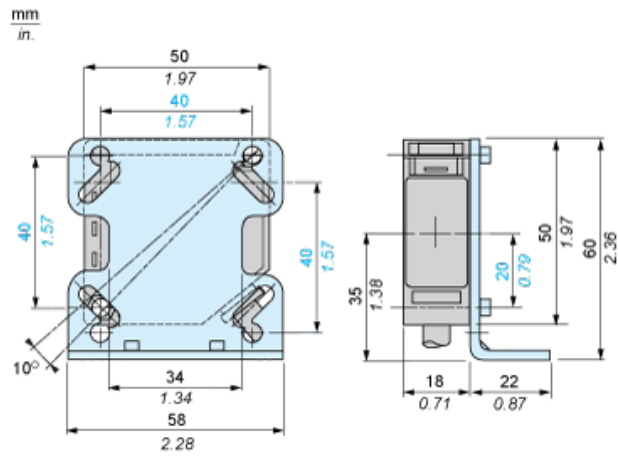

Bracket fixing

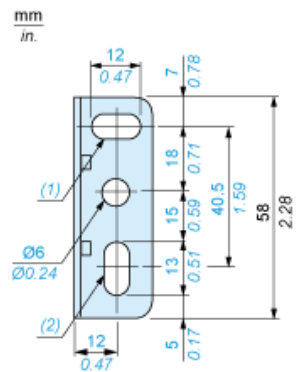

- (1) 1 elongated hole Ø 6 x 12
- (2) 1 elongated hole Ø 6 x 13

Wiring Schemes

NO/NC Programming

PNP Output

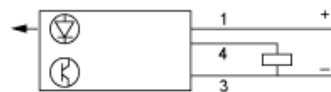

NPN Output



BN : Brown
BU : Blue
BK : Black

Detection Curves

Variation of Usable Sensing Distance S_u

Adjustment at 10 cm

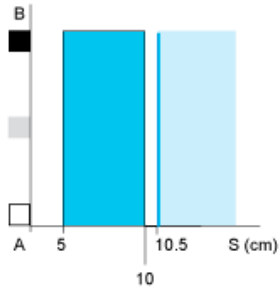

Adjustment at 1 m

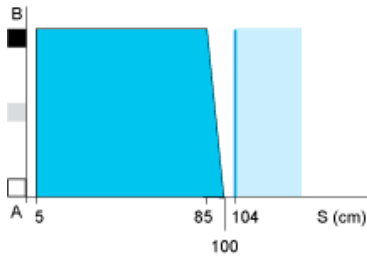

- (1) Black
- (2) Grey
- (3) White
- (4) Sensing range
- (5) Non sensing zone (matt surfaces)

A-B : Object reflection coefficient

- (1) Black 6%
- (2) Grey 18%
- (3) White 90%
- (4) Sensing range
- (5) Non sensing zone (matt surfaces)

Sensing Distance Adjustment

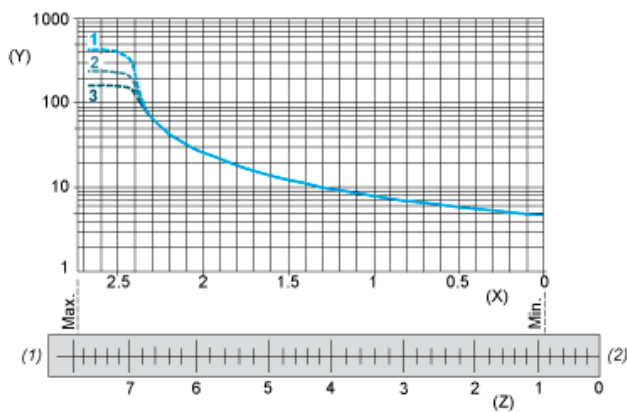

- 1 : White 90%
- 2 : Grey 18%
- 3 : Black 6%
- (Y) Sensing distance (cm)
- (X) Number of turns on potentiometer
- (Z) Setting indicator position (mm)

Relative Difference in Sensing Distances According to Object Colour

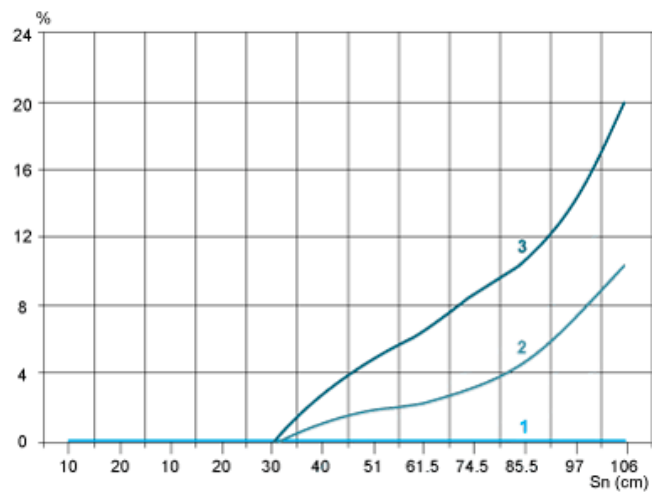

- 1 : White 90%
- 2 : Grey 18%
- 3 : Black 6%