

XCMD25F2L2

Limit switch, Limit switches XC Standard, XCMD, M12 steel roller plunger, 1NC+1 NO, slow, 2 m



Main

Range of product	Telemecanique Limit switches XC Standard
Series name	Standard format
Product or component type	Limit switch
Device short name	XCMD
Sensor design	Miniature
Body type	Fixed
Head type	M12 plunger head
Material	Metal
Body material	Zamak
Head material	Zamak
Fixing mode	By the head
Movement of operating head	Linear
Type of operator	Spring return roller plunger metal
Type of approach	Lateral approach, 2 directions
Number of poles	2
Contacts type and composition	1 NC + 1 NO
Contact operation	Slow-break

Complementary

Switch actuation	By 30° cam
Electrical connection	Removable cable connector
Cable length	2 m
Cable composition	5 x 0.75 mm ²
Wire insulation material	PvR
Contacts insulation form	Zb
Positive opening	With
Positive opening minimum force	35 N
Minimum force for tripping	7 N
Maximum actuation speed	10 cm/s
Contact code designation	B300, AC-15 (U _e = 240 V), I _e = 1.5 A conforming to EN/IEC 60947-5-1 appendix A R300, DC-13 (U _e = 250 V), I _e = 0.1 A conforming to EN/IEC 60947-5-1 appendix A
[Ui] rated insulation voltage	300 V (pollution degree 3) conforming to UL 508 400 V (pollution degree 3) conforming to IEC 60947-5-1 300 V (pollution degree 3) conforming to CSA C22.2 No 14
Maximum resistance across terminals	25 mOhm conforming to IEC 60255-7 category 3
[Uimp] rated impulse withstand voltage	4 kV conforming to IEC 60664 4 kV conforming to IEC 60947-1
Short-circuit protection	6 A cartridge fuse, type gG
Electrical durability	5000000 Cycles, DC-13, 120 V, 1 W, operating rate <60 cyc/mn, load factor: 0.5 conforming to IEC 60947-5-1 appendix C 5000000 Cycles, DC-13, 24 V, 3 W, operating rate <60 cyc/mn, load factor: 0.5 conforming to IEC 60947-5-1 appendix C 5000000 cycles, DC-13, 48 V, 2 W, operating rate <60 cyc/mn, load factor: 0.5 conforming to IEC 60947-5-1 appendix C
Mechanical durability	10000000 cycles

Width	30 mm
Height	50 mm
Depth	16 mm
Net weight	0.205 kg

Environment

Shock resistance	25 gn for 18 ms conforming to IEC 60068-2-27
Vibration resistance	25 gn (f= 10...500 Hz) conforming to IEC 60068-2-6
IP degree of protection	IP66 conforming to IEC 60529 IP67 conforming to IEC 60529 IP68 conforming to IEC 60529
IK degree of protection	IK06 conforming to EN 62262
Overvoltage category	Class I conforming to IEC 61140 Class I conforming to NF C 20-030
Ambient air temperature for operation	-25...70 °C
Ambient air temperature for storage	-40...70 °C
Protective treatment	TC
Product certifications	CSA CCC UL
Standards	EN/IEC 60204-1 UL 508 CSA C22.2 No 14 EN/IEC 60947-5-1

Packing Units

Unit Type of Package 1	PCE
Number of Units in Package 1	1
Package 1 Height	3 cm
Package 1 Width	13 cm
Package 1 Length	13 cm
Package 1 Weight	275 g
Unit Type of Package 2	S03
Number of Units in Package 2	40
Package 2 Height	30 cm
Package 2 Width	30 cm
Package 2 Length	40 cm
Package 2 Weight	11.554 kg

Offer Sustainability

Sustainable offer status	Green Premium product
Environmental Disclosure	Product Environmental Profile
Circularity Profile	End of Life Information
California proposition 65	WARNING: This product can expose you to chemicals including: Diisononyl phthalate (DINP), which is known to the State of California to cause cancer, and Di-isodecyl phthalate (DIDP), which is known to the State of California to cause birth defects or other reproductive harm. For more information go to www.P65Warnings.ca.gov
For all Reach Rohs enquiries contact us at	sustainability@tesensors.com

Contractual warranty

Warranty	18 months
----------	-----------

Dimensions

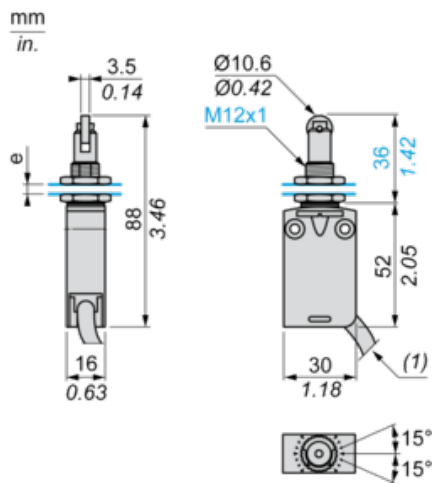

(1) External diameter of cable 7.5 mm.
e : 8 mm max, panel cut-out Ø 12.5 mm.

Mounting

Sweep of Connecting Cable

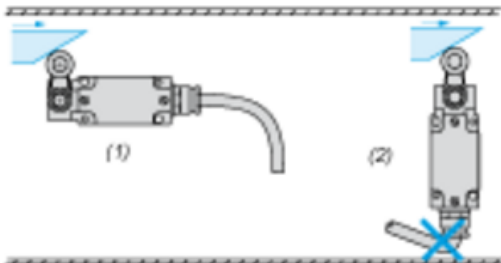

- (1) Recommended
- (2) To be avoided

Panel Mounting

Mounting and Fixing Limit Switches by the Head

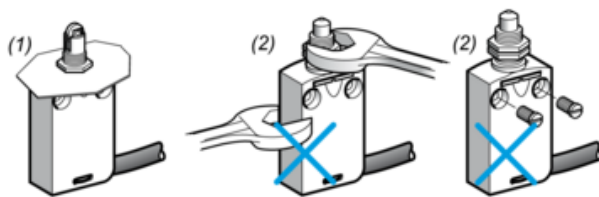

- (1) Recommended
- (2) Forbidden

Setting-up

Plunger or Multi-directional Heads

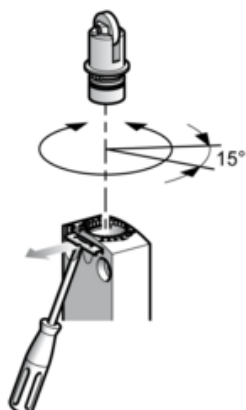

Wiring Diagram

2-pole N/C + N/O Break before Make, Slow Break

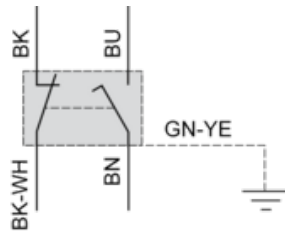

- (BK) Black
- (BK-WH) Black White
- (BU) Blue
- (BN) Brown
- (GN-YE) Green Yellow

Characteristics of Actuation

Switch Actuation by 30° Cam

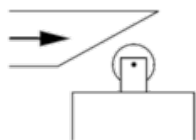

Functional Diagram

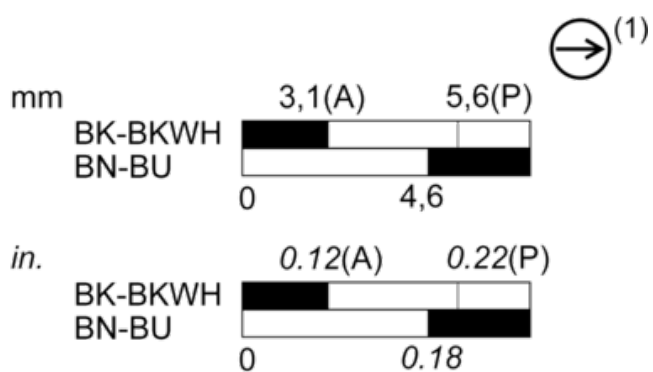

■ (2)
 □ (3)

(P) Positive opening point

(A) Cam displacement

(1) NC contact with positive opening operation

(2) Closed

(3) Open

(BK) Black

(BK-WH) Black White

(BU) Blue

(BN) Brown