

# XCKML115

Limit switch, Limit switches XC Standard, XCKML, thermoplastic roller lever, 2x(1NC +1NO), snap, Pg13



## Main

Range of product	Telemecanique Limit switches XC Standard
Series name	Standard format
Product or component type	Limit switch
Device short name	XCKML
Body type	Fixed
Head type	Rotary head
Material	Metal
Body material	Zamak
Fixing mode	By the body
Movement of operating head	Rotary
Type of operator	Spring return roller lever thermoplastic
Type of approach	Lateral approach, 2 directions
Cable entry	3 entries tapped for Pg 13.5 cable gland, cable outer diameter: 9...12 mm
Number of poles	4
Contacts type and composition	2 x (1 NC + 1 NO)
Contact operation	Snap action

## Complementary

Switch actuation	By 30° cam
Electrical connection	Screw-clamp terminals, clamping capacity: 1 x 0.34...2 x 1.5 mm <sup>2</sup>
Contacts insulation form	Zb
Number of steps	1
Positive opening	With
Positive opening minimum torque	0.5 N.m
Minimum torque for tripping	0.2 N.m
Minimum actuation speed	0.01 m/min
Maximum actuation speed	1.5 m/s
[I <sub>th</sub> ] conventional enclosed thermal current	10 A AC
[U <sub>i</sub> ] rated insulation voltage	300 V conforming to UL 508 500 V (pollution degree 3) conforming to IEC 60947-1 300 V conforming to CSA C22.2 No 14
Maximum resistance across terminals	25 MOhm conforming to IEC 60255-7 category 3
[U <sub>imp</sub> ] rated impulse withstand voltage	6 kV conforming to IEC 60664 6 kV conforming to IEC 60947-1
Electrical durability	5000000 Cycles, DC-13, inductive load type, 120 V, 4 W, operating rate <60 cyc/mn, load factor: 0.5 conforming to IEC 60947-5-1 appendix C 5000000 Cycles, DC-13, inductive load type, 24 V, 7 W, operating rate <60 cyc/mn, load factor: 0.5 conforming to IEC 60947-5-1 appendix C 5000000 cycles, DC-13, inductive load type, 48 V, 10 W, operating rate <60 cyc/mn, load factor: 0.5 conforming to IEC 60947-5-1 appendix C
Mechanical durability	3000000 cycles
Width	77 mm
Height	81 mm
Depth	36 mm

The information provided in this documentation contains general descriptions and/or technical characteristics of the performance of the products contained herein. This documentation is not intended as a substitute for and is not to be used for determining suitability or reliability of these products for specific user applications. It is the duty of any such user or integrator to perform the appropriate and complete risk analysis, evaluation and testing of the products with respect to the relevant specific application or use thereof. Neither TWSS Holding nor any of its affiliates or subsidiaries shall be responsible or liable for misuse of the information contained herein.

Net weight	0.43 kg
Terminals description ISO n°1	(21-22)NC (13-14)NO

## Environment

Shock resistance	50 gn for 11 ms conforming to EN/IEC 60068-2-27
Vibration resistance	25 gn (f= 10...500 Hz) conforming to EN/IEC 60068-2-6
IP degree of protection	IP66 conforming to EN/IEC 60529
IK degree of protection	IK05 conforming to EN 50102
Electrical shock protection class	Class I conforming to IEC 61140 Class I conforming to NF C 20-030
Ambient air temperature for operation	-25...70 °C
Ambient air temperature for storage	-40...70 °C
Protective treatment	TC
Product certifications	UL CSA
Standards	UL 508 CSA C22.2 No 14 EN 60947-5-1 IEC 60204-1 EN 60204-1 IEC 60947-5-1

## Packing Units

Unit Type of Package 1	PCE
Number of Units in Package 1	1
Package 1 Height	5.5 cm
Package 1 Width	9.1 cm
Package 1 Length	15.2 cm
Package 1 Weight	481.0 g
Unit Type of Package 2	S03
Number of Units in Package 2	20
Package 2 Height	30.0 cm
Package 2 Width	30.0 cm
Package 2 Length	40.0 cm
Package 2 Weight	9.916 kg

## Offer Sustainability

Sustainable offer status	Green Premium product
Environmental Disclosure	 <a href="#">Product Environmental Profile</a>
Circularity Profile	No need of specific recycling operations
California proposition 65	WARNING: This product can expose you to chemicals including: Diisononyl phthalate (DINP), which is known to the State of California to cause cancer, and Di-isodecyl phthalate (DIDP), which is known to the State of California to cause birth defects or other reproductive harm. For more information go to <a href="http://www.P65Warnings.ca.gov">www.P65Warnings.ca.gov</a>
For all Reach Rohs enquiries contact us at	<a href="mailto:sustainability@tesensors.com">sustainability@tesensors.com</a>

## Contractual warranty

Warranty	18 months
----------	-----------

Dimensions

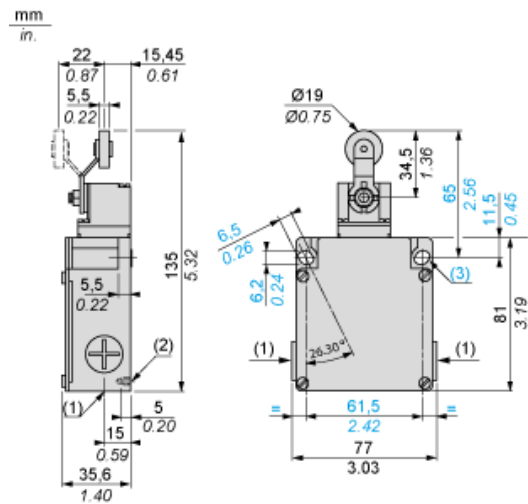

- (1) 3 tapped entries for Pg 13.5 cable gland
- (2) 2 centring holes  $\text{Ø} 3.9 \pm 0.2$ , for cover fixing holes alignment.
- Ø : 2 elongated holes 6.2 x 6.5, inclined at 26° 30' to the vertical axis, for M5 screws.

---

## Mounting with Cable Entry

---

### Position of Cable Gland

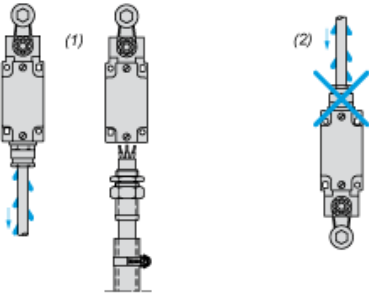

- (1) Recommended
- (2) To be avoided

---

## Mounting with Rotary Heads and Levers

---

### Type of Cam

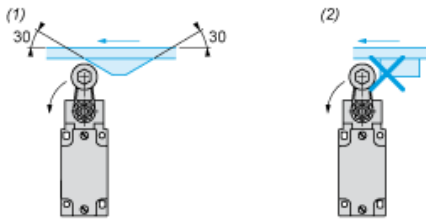

- (1) Recommended
- (2) To be avoided

---

## Wiring Diagram

---

2 x 2-pole NC + NO Snap Action

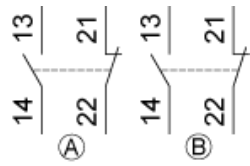

Characteristics of Actuation

Switch Actuation by 30° Cam

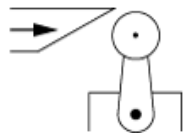

Functionnal Diagram

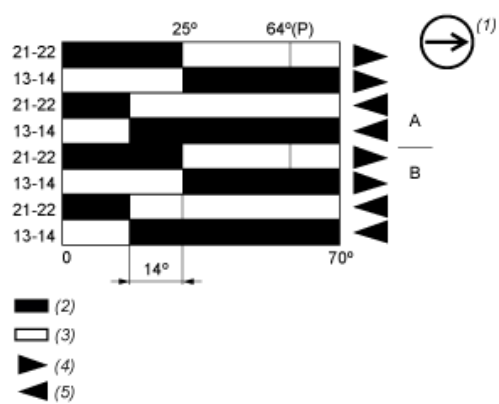

- (P) Positive opening point
- (1) NC contact with positive opening operation
- (2) Closed
- (3) Open
- (4) Tripping
- (5) Resetting